

Dia 1: Horizontal Fix to Timber - Side View

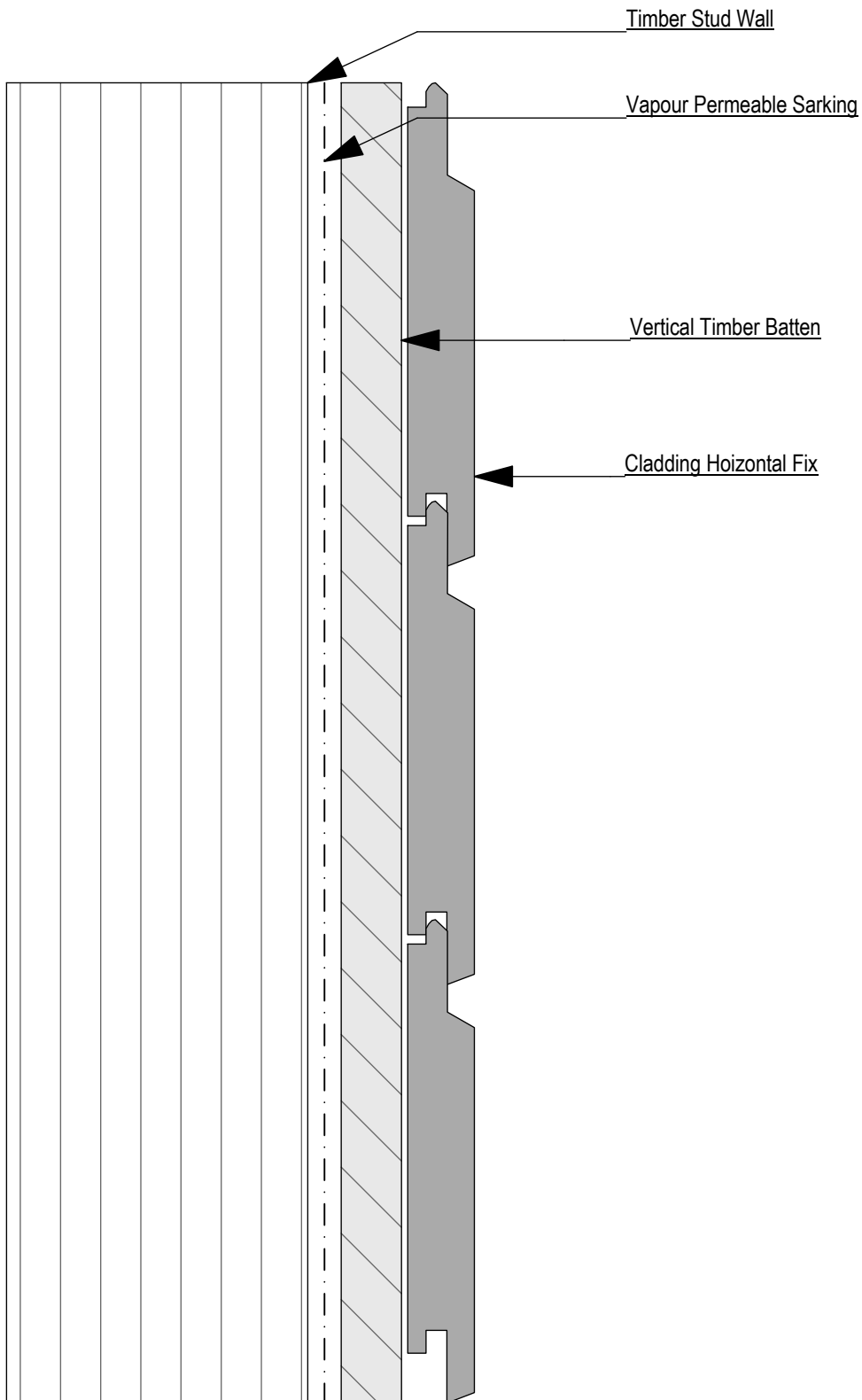

Dia 2: Vertical Fix to Timber - Side View

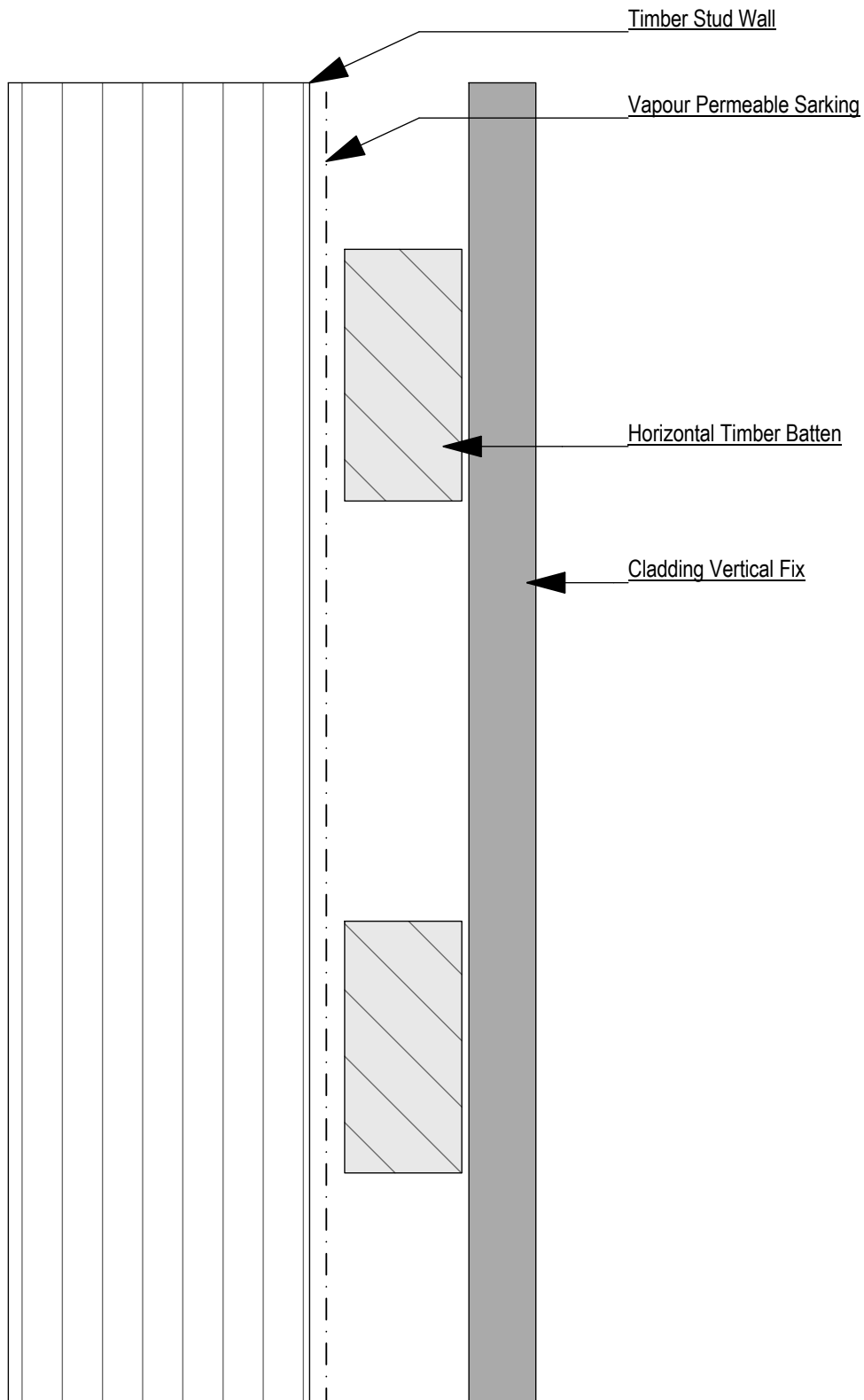

Dia 3: Horizontal Fix to Msonary - Side View

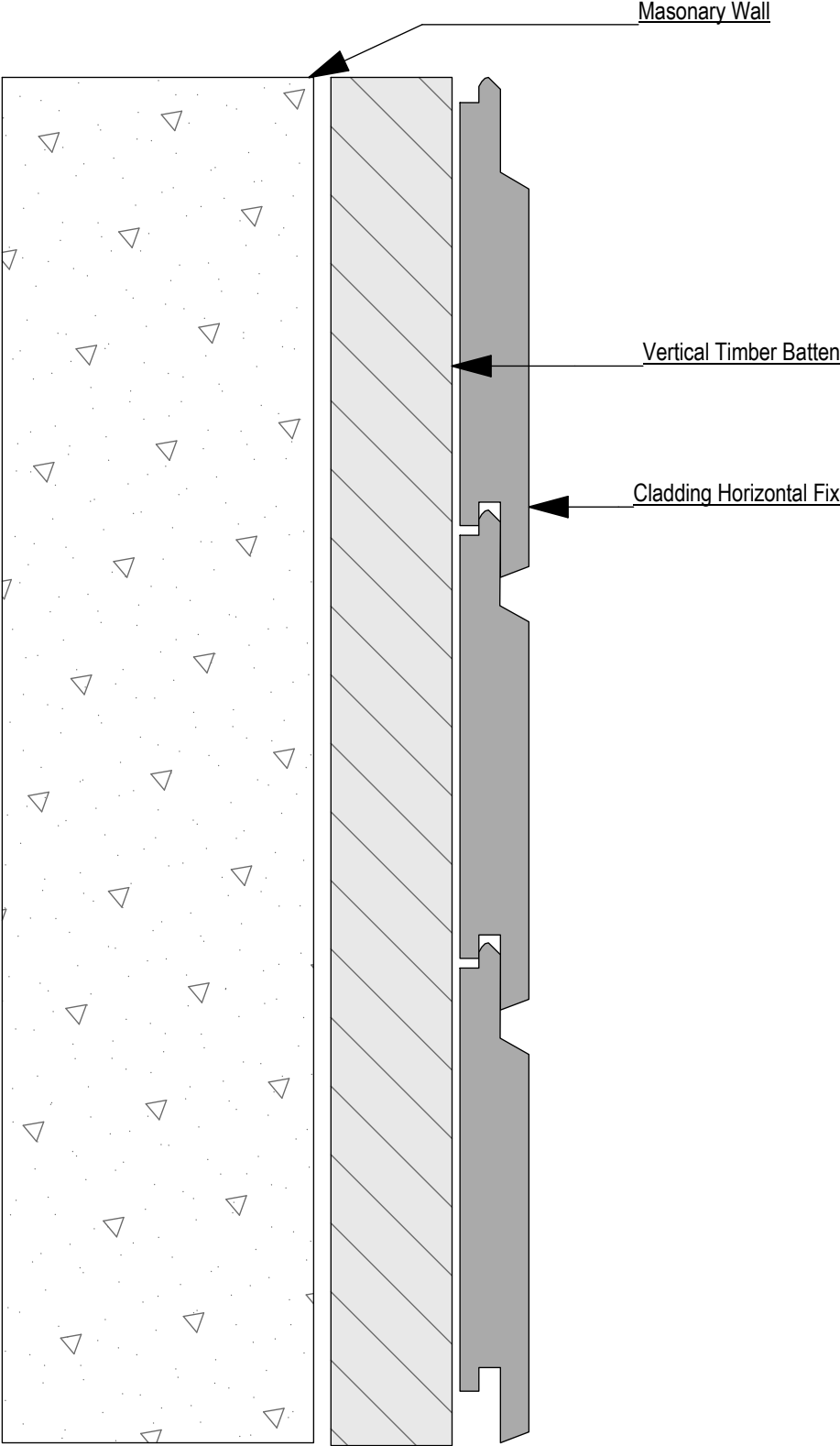

Dia 4: Vertical Fix to Masonry - Side View

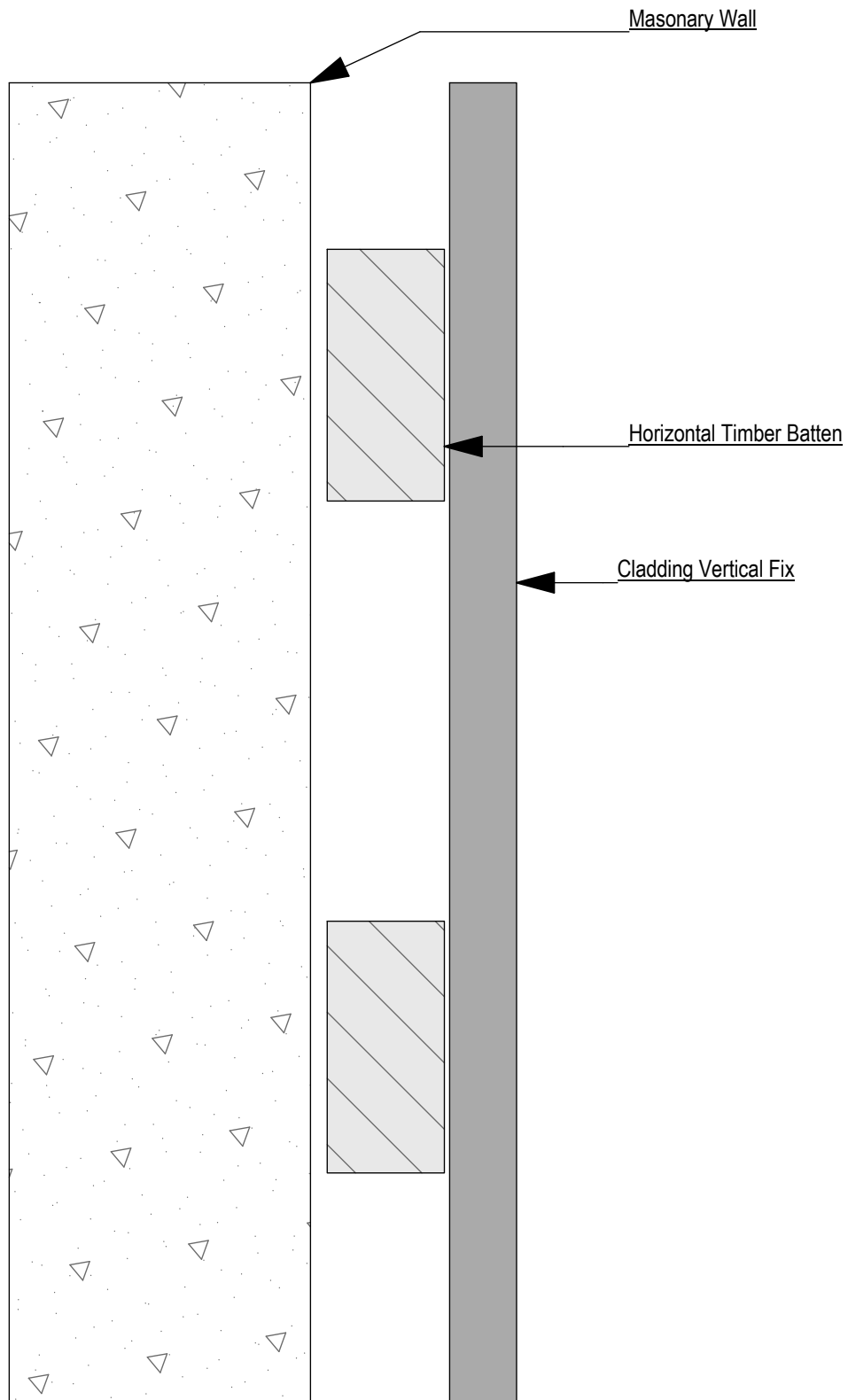

Dia 5: Horizontal Fix to Timber External Corner - with Timber Profile - Top View

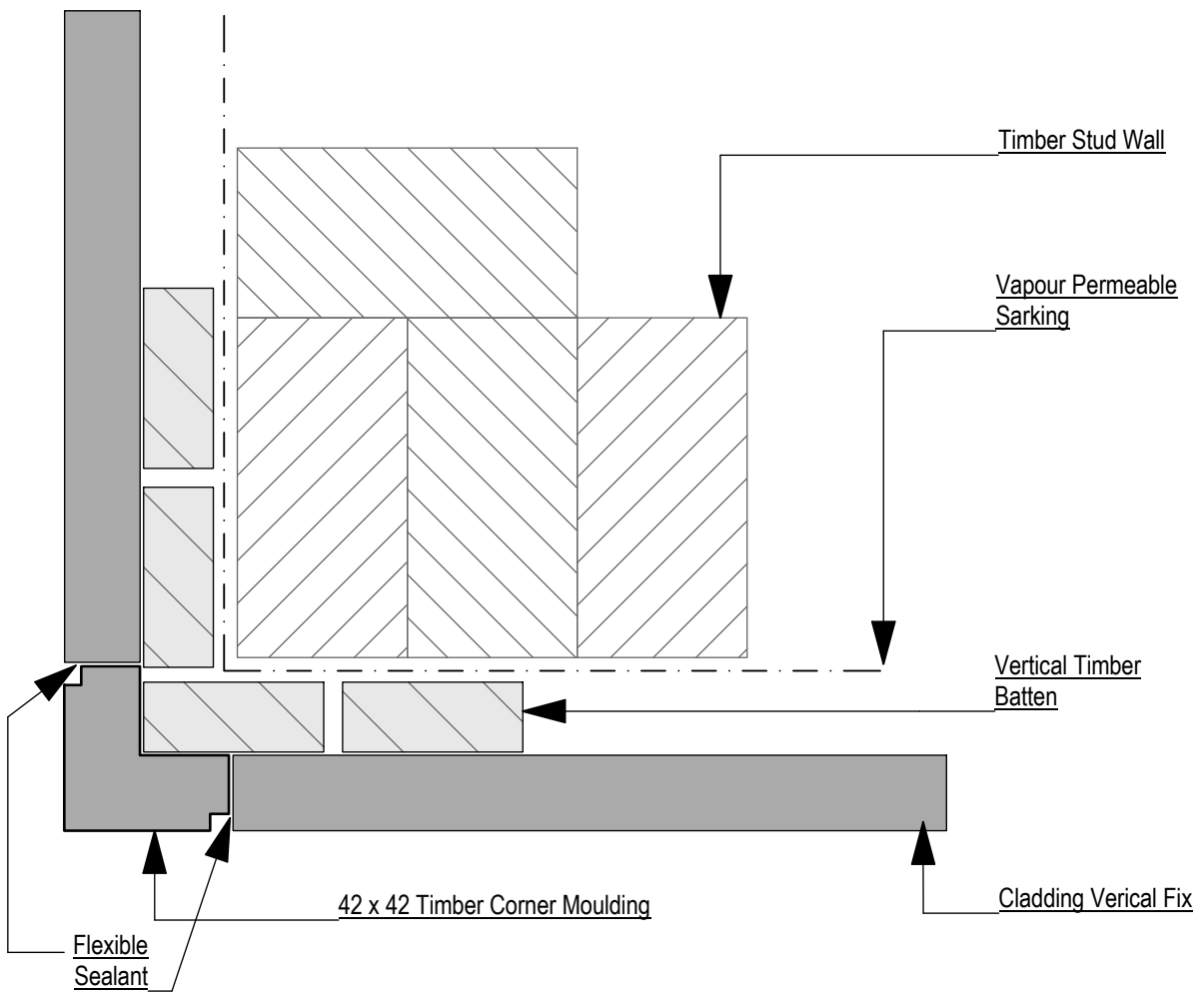

Dia 6: Vertical Fix to Timber External Corner - with Timber Profile - Top View

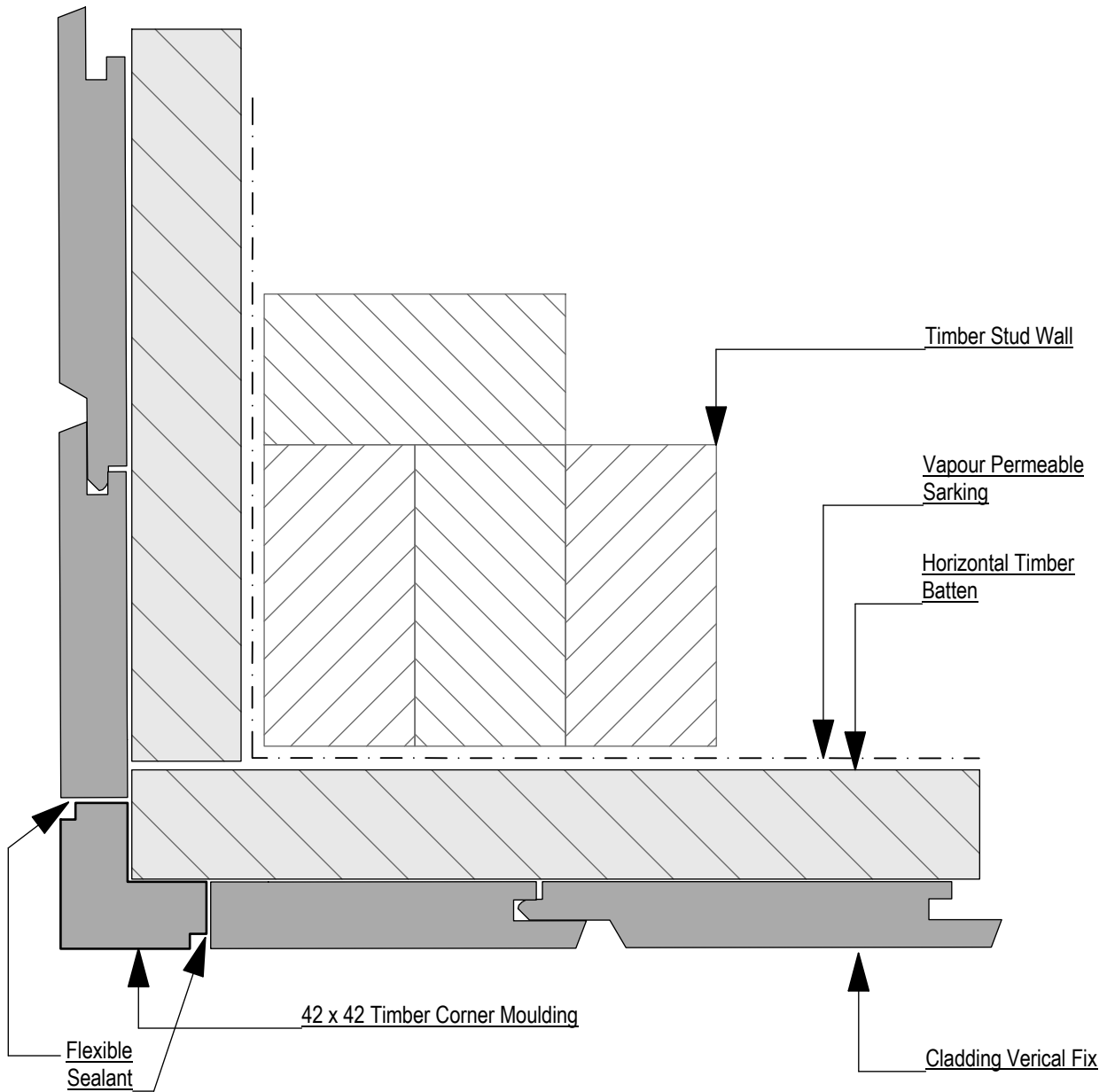

Dia 7: Horizontal Fix to Masonry External Corner - with Timber Profile - Top View

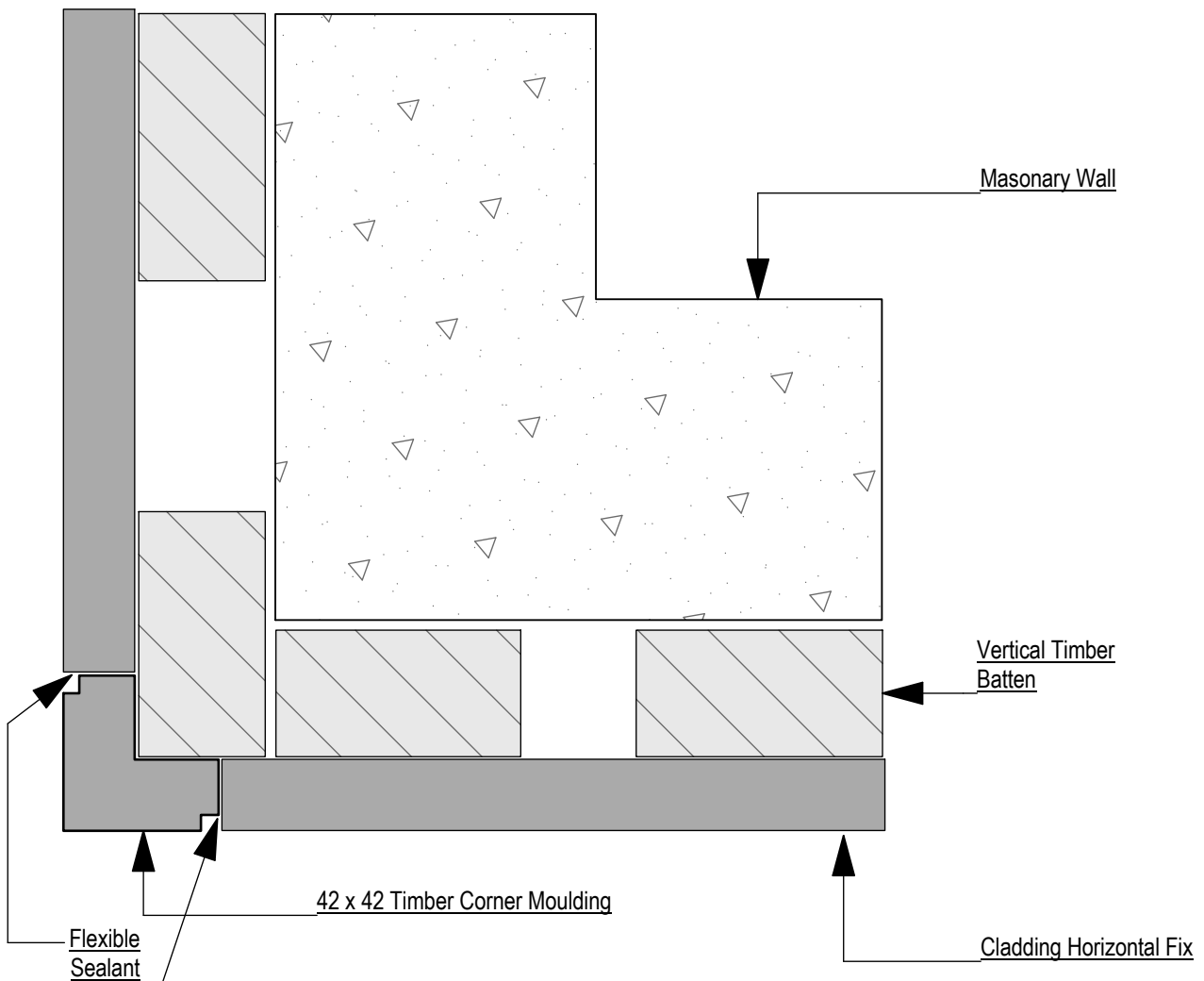

Dia 8: Vertical Fix to Masonry External Corner - with Timber Profile - Top View

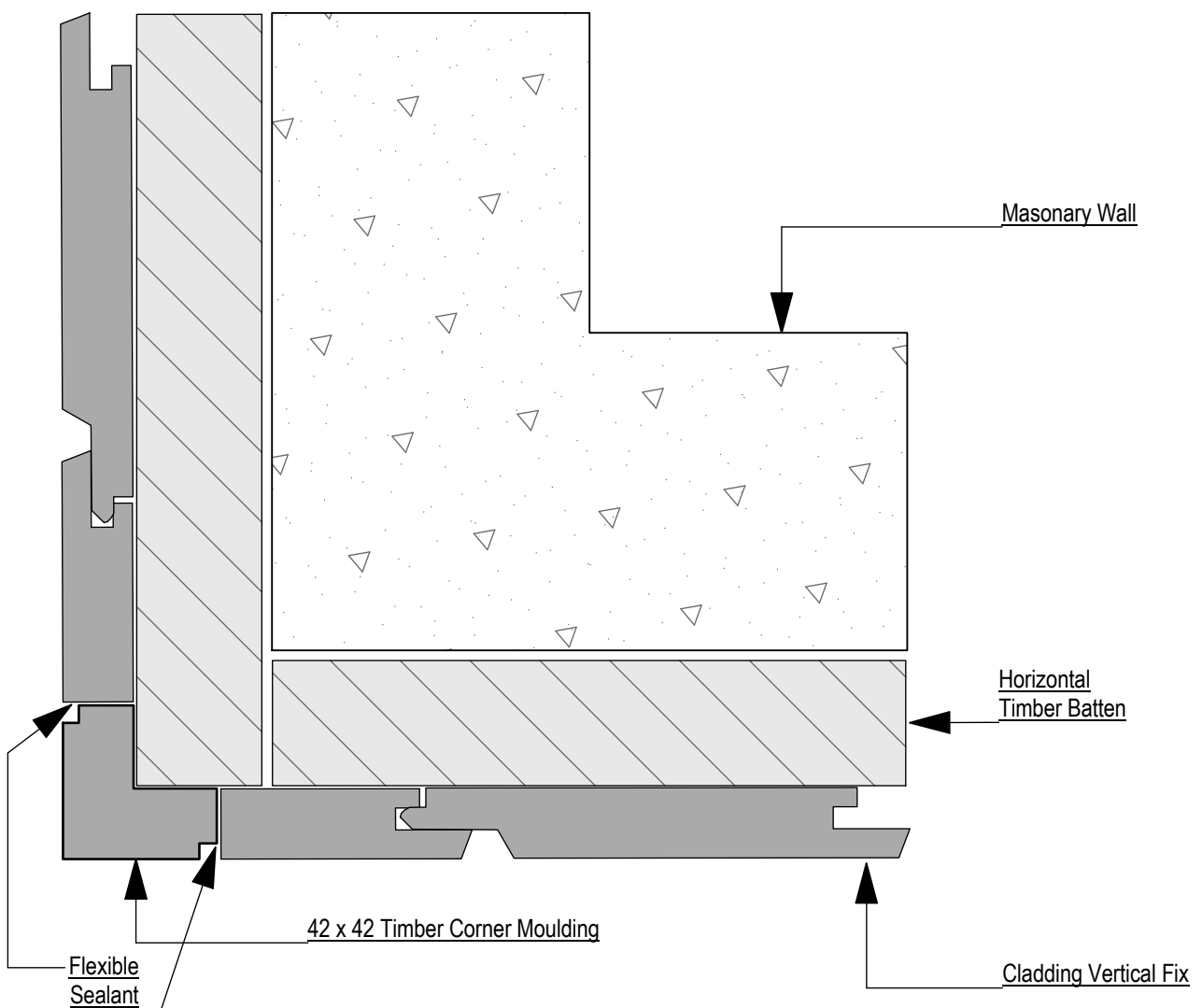

Dia 9: Horizontal Fix to Timber External Corner - with Aluminium Y Profile - Top View

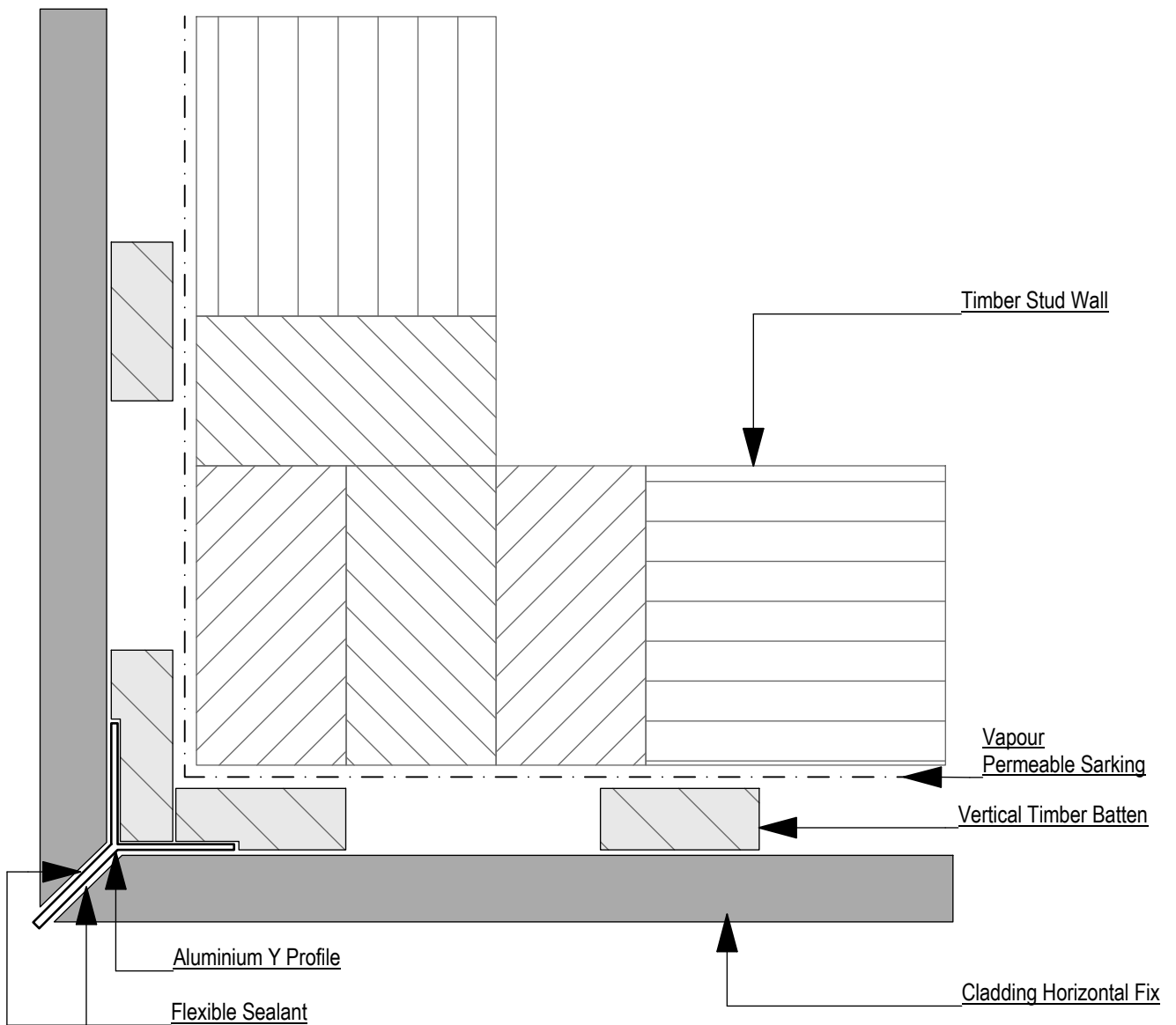

Dia 10: Vertical Fix to Timber External Corner - with Aluminium Y Profile - Top View

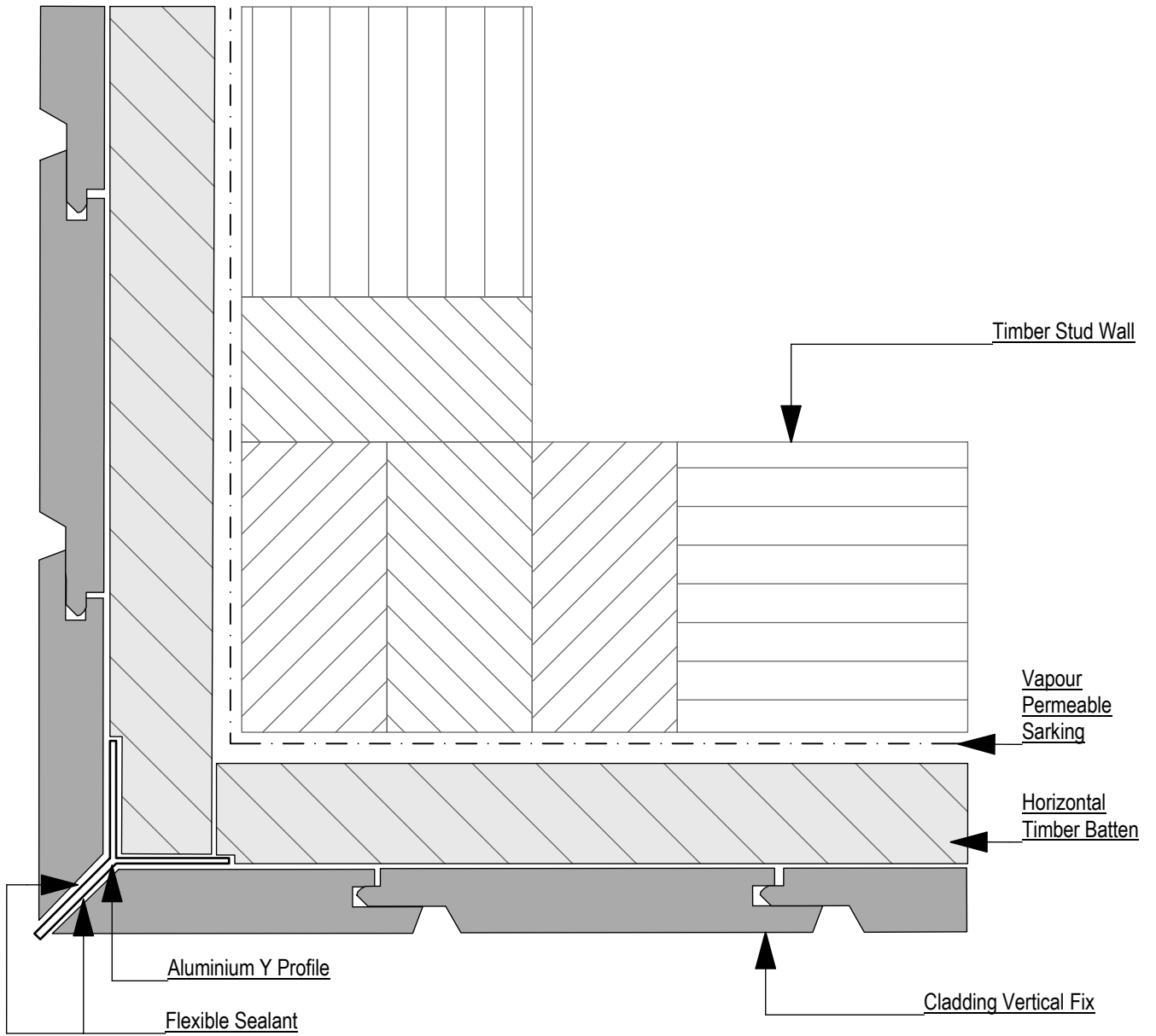

Dia 11: Horizontal Fix to Masonry External Corner
- with Aluminium Y Profile - Top View

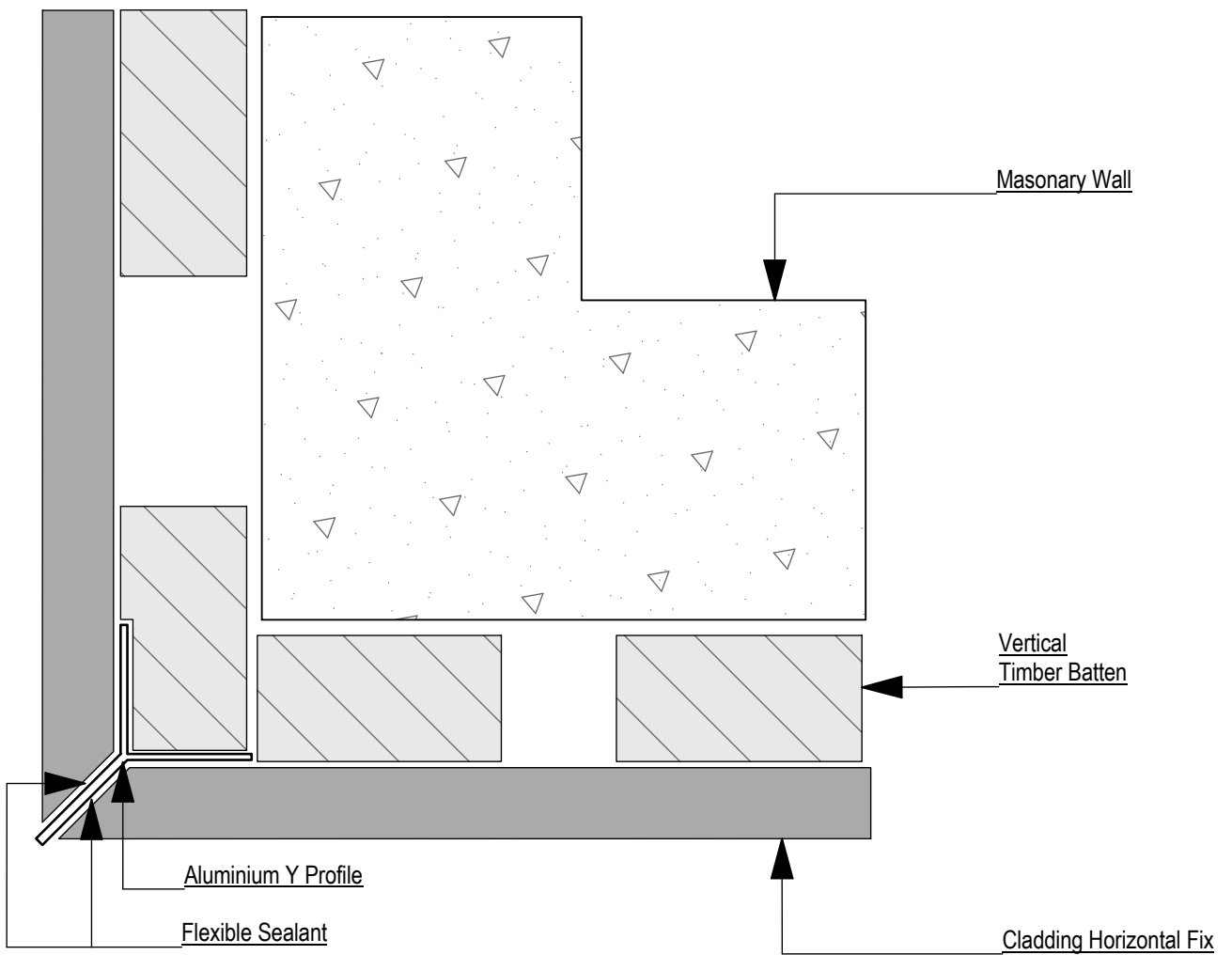

Dia 12: Vertical Fix to Masonry External Corner
- with Aluminium Y Profile - Top View

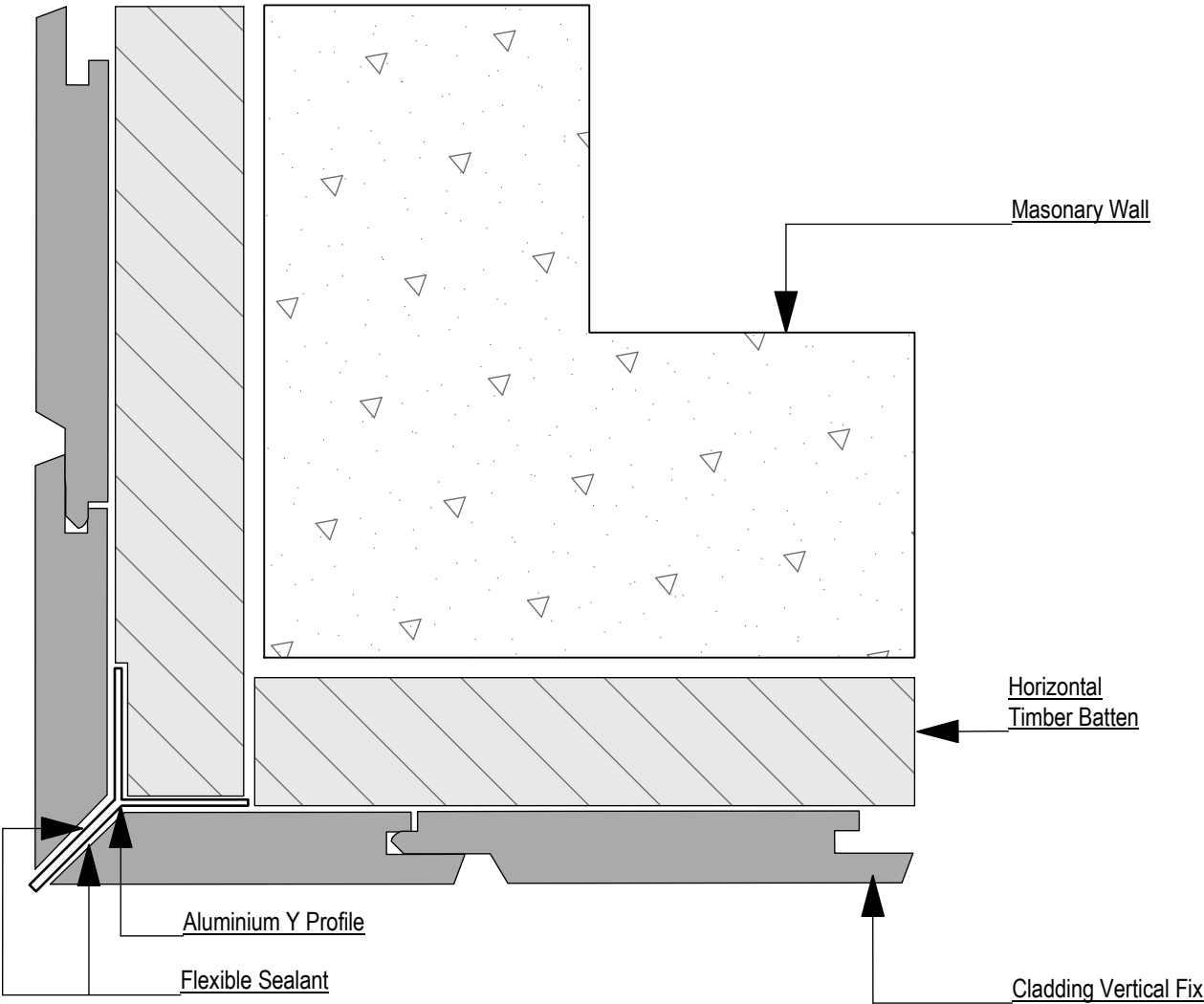

Dia 13: Horizontal Fix to Timber Internal Corner - with Timber Profile- Top View

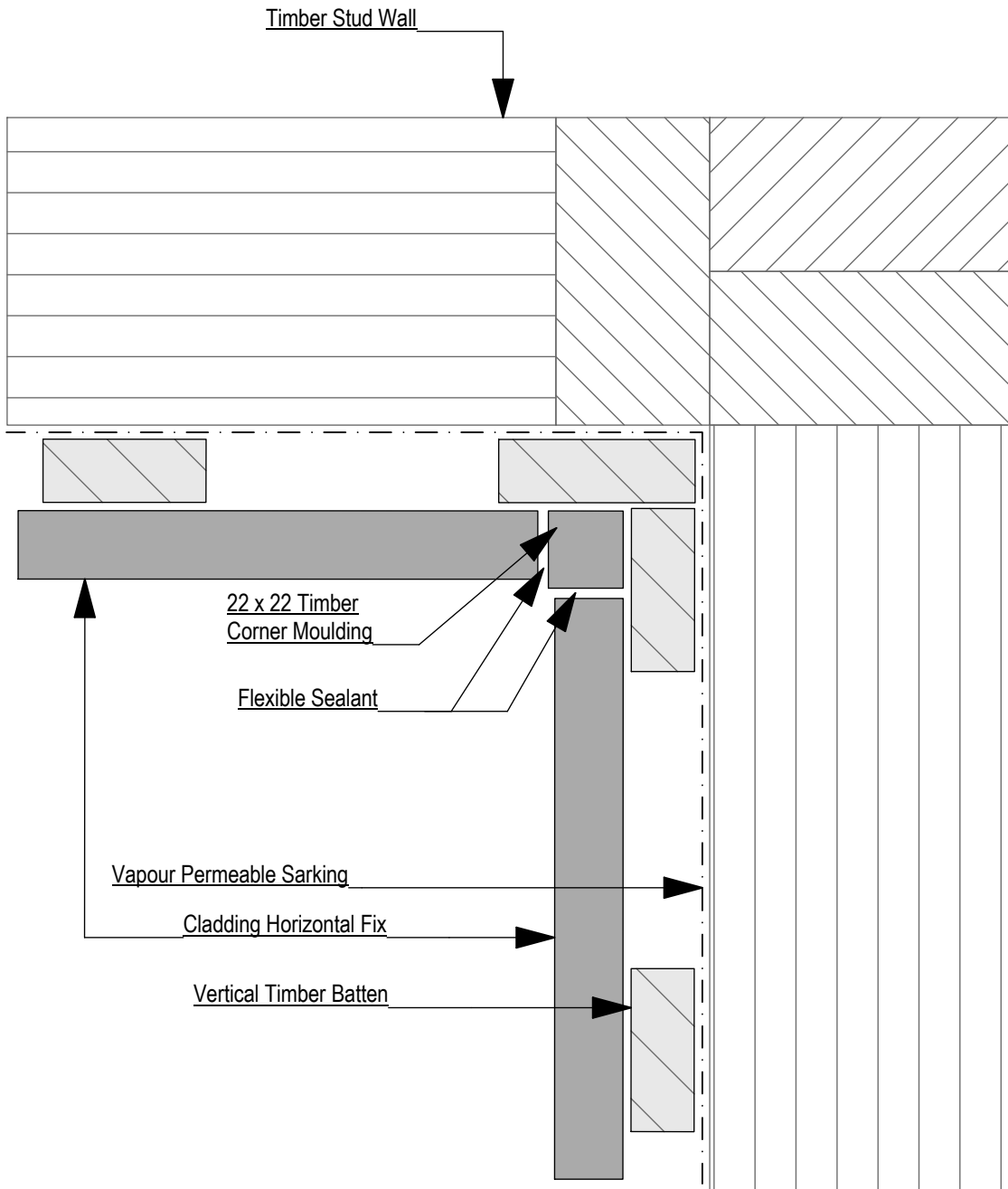

Dia 14: Vertical Fix to Timber Internal Corner - with Timber Profile- Top View

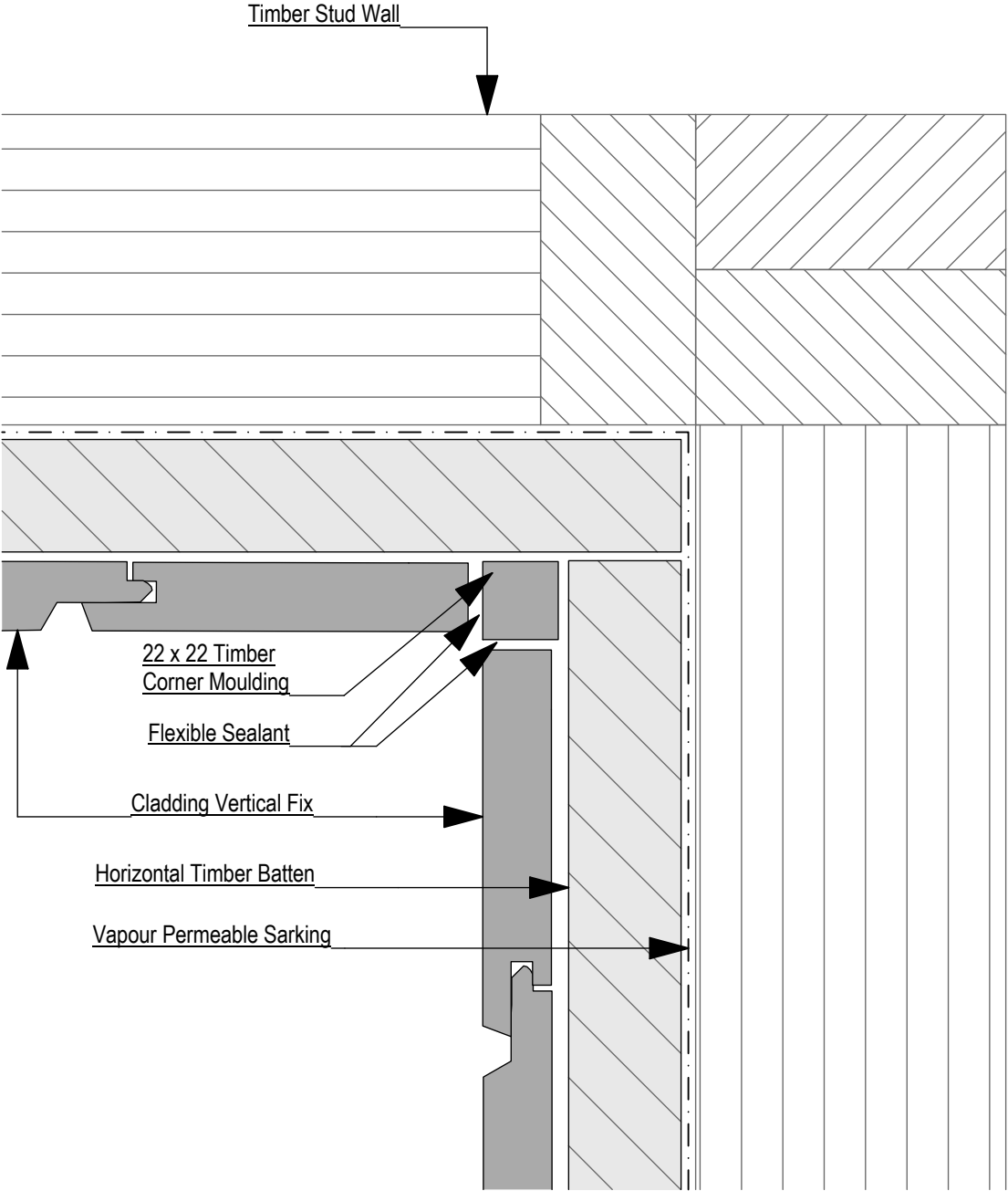

Dia 15: Horizontal Fix to Masonry Internal Corner - with Timber Profile- Top View

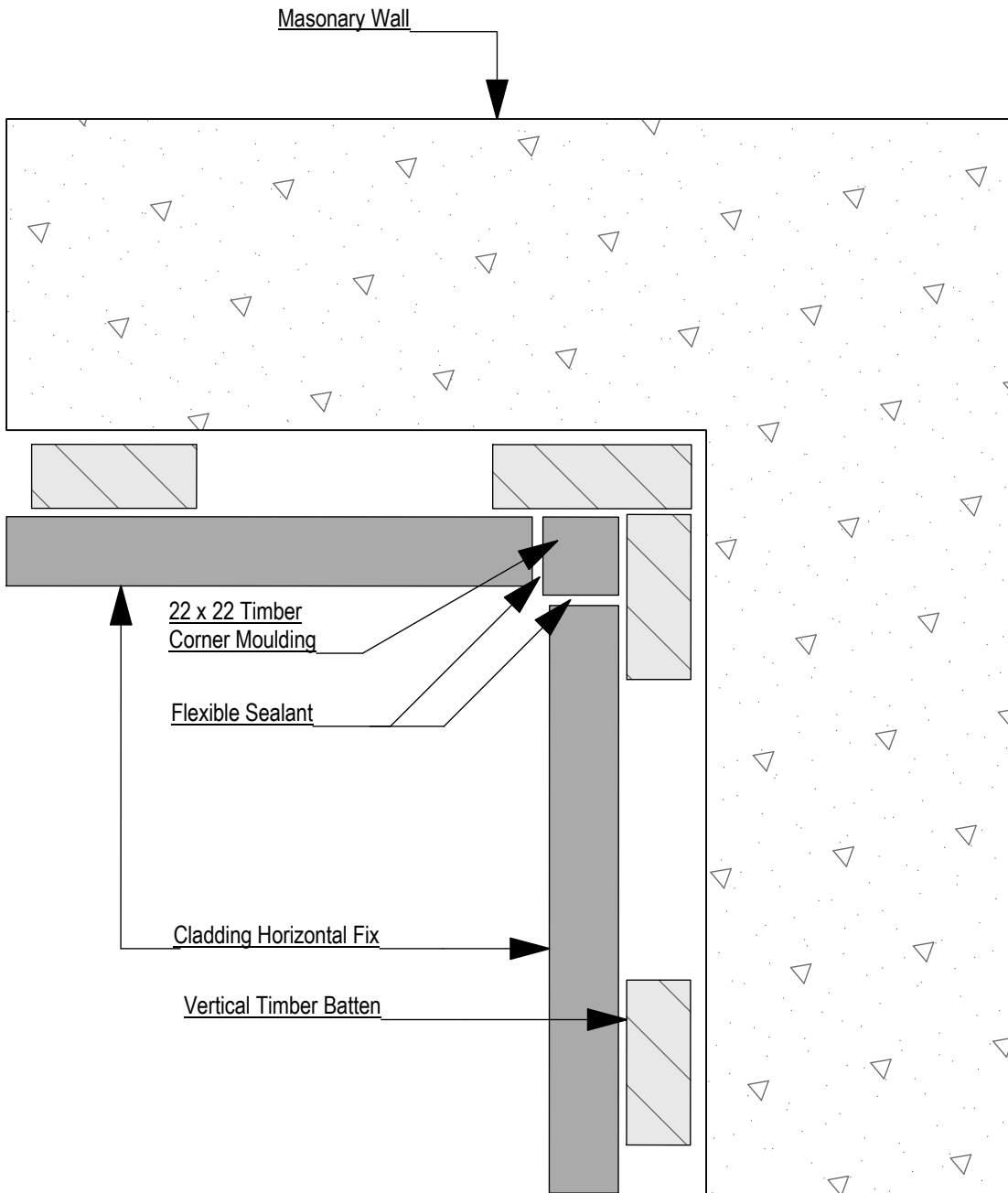

Dia 16: Vertical Fix to Masonry Internal Corner - with Timber Profile - Top View

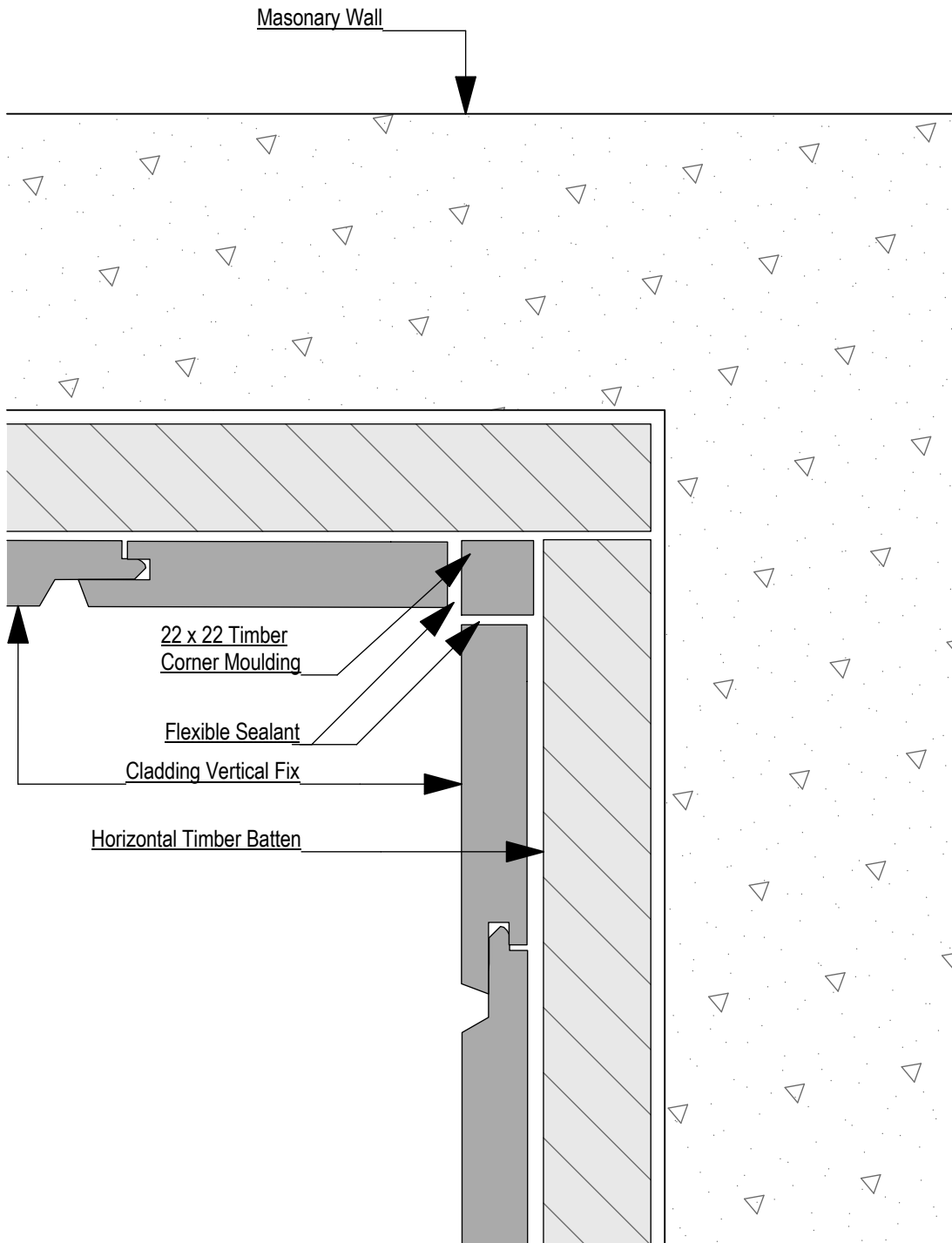

Dia 17: Horizontal Fix to Timber Wall - with Alumium F Profile - Base of Wall Side View

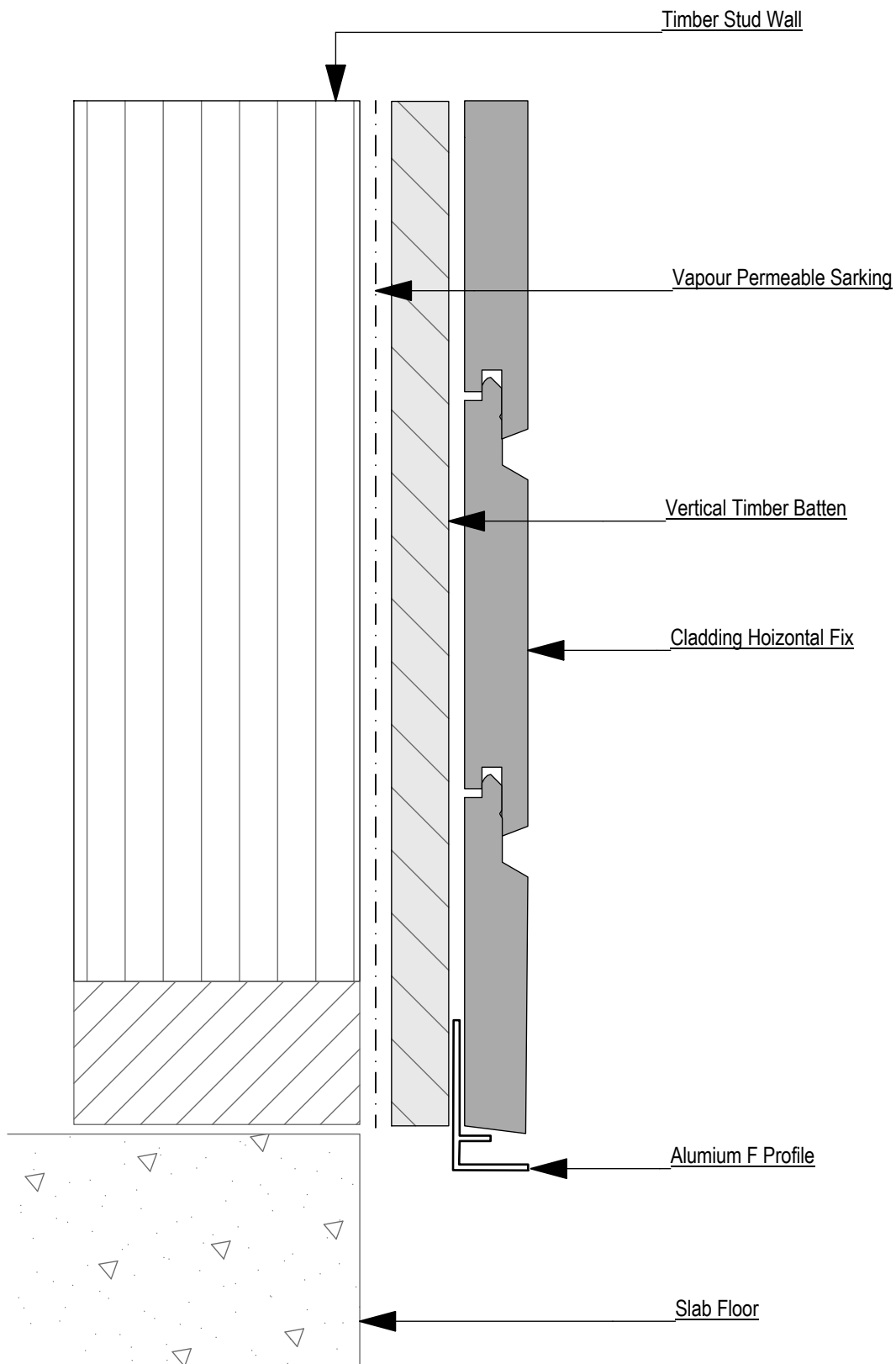

Dia 18: Vertical Fix to Timber Wall - with Alumium F Profile - Base of Wall Side View

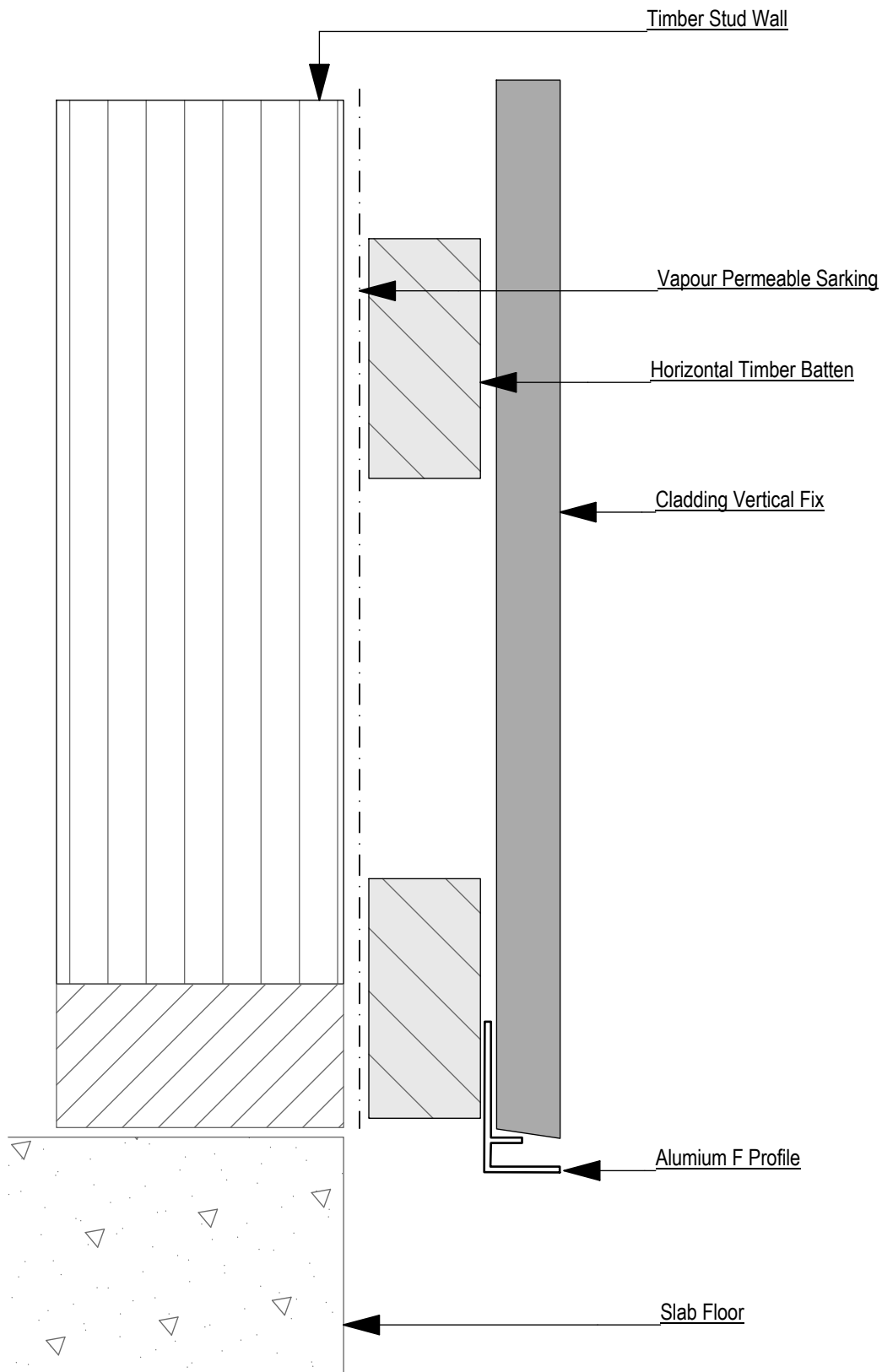

Dia 19: Horizontal Fix to Timber Wall - with Timber Profile - Ceiling Eaves Side View

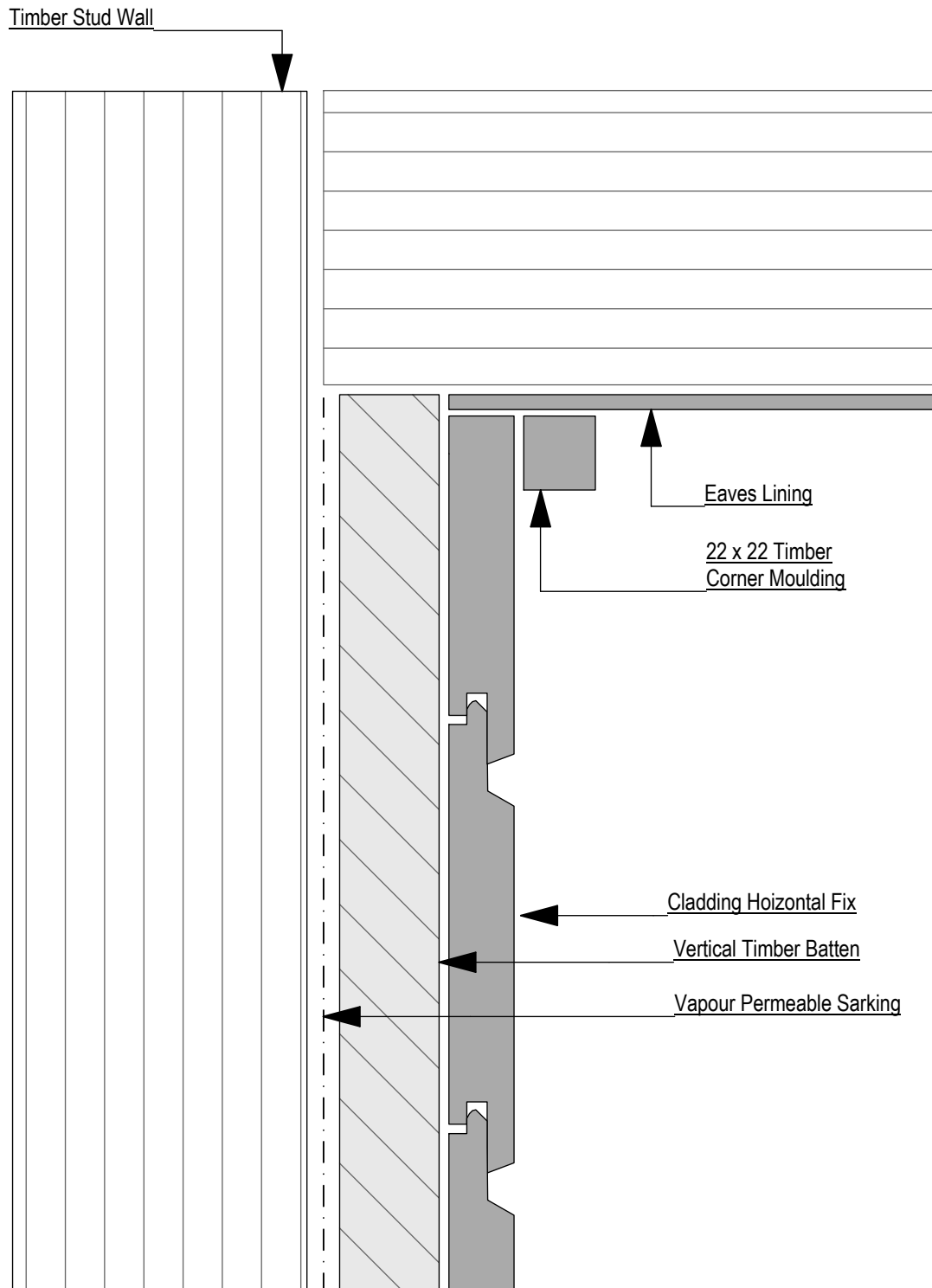

Dia 20: Vertical Fix to Timber Wall - with Timber Profile - Ceiling Eaves Side View

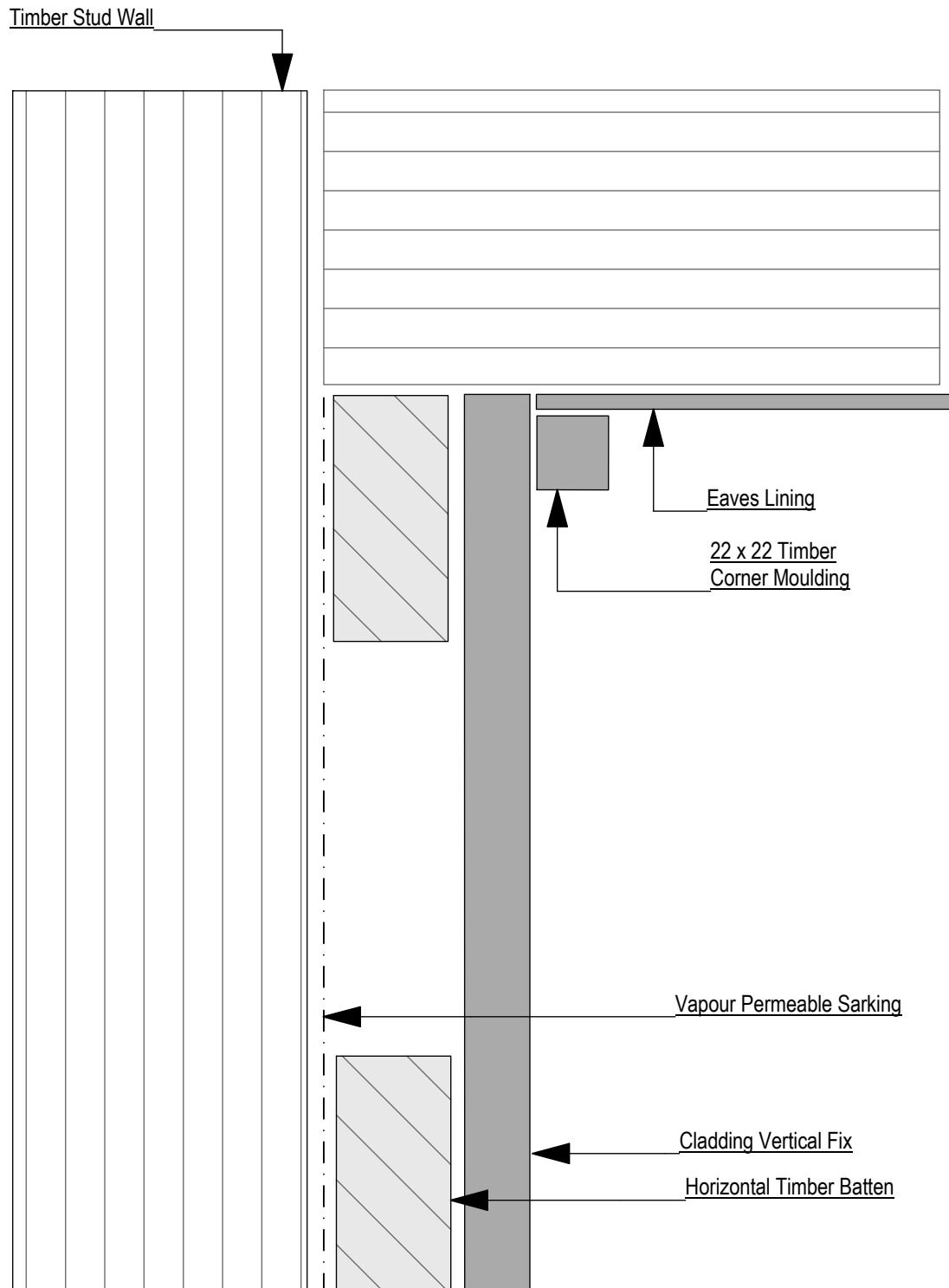

Dia 21: Horizontal Fix to Timber Wall Wall/Roof Detail - Side View

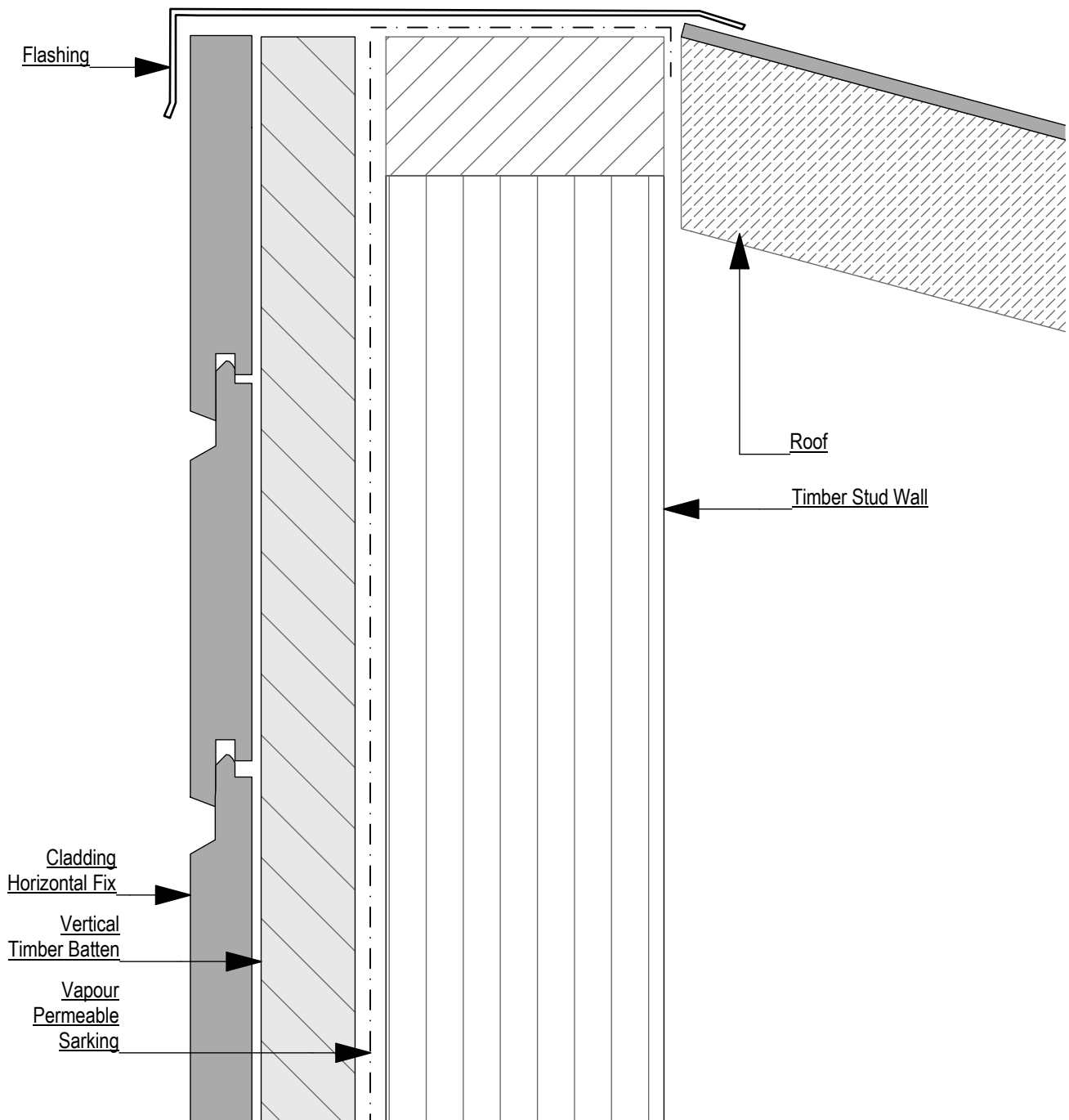

Dia 22: Vertical Fix to Timber Wall Wall/Roof Detail - Side View

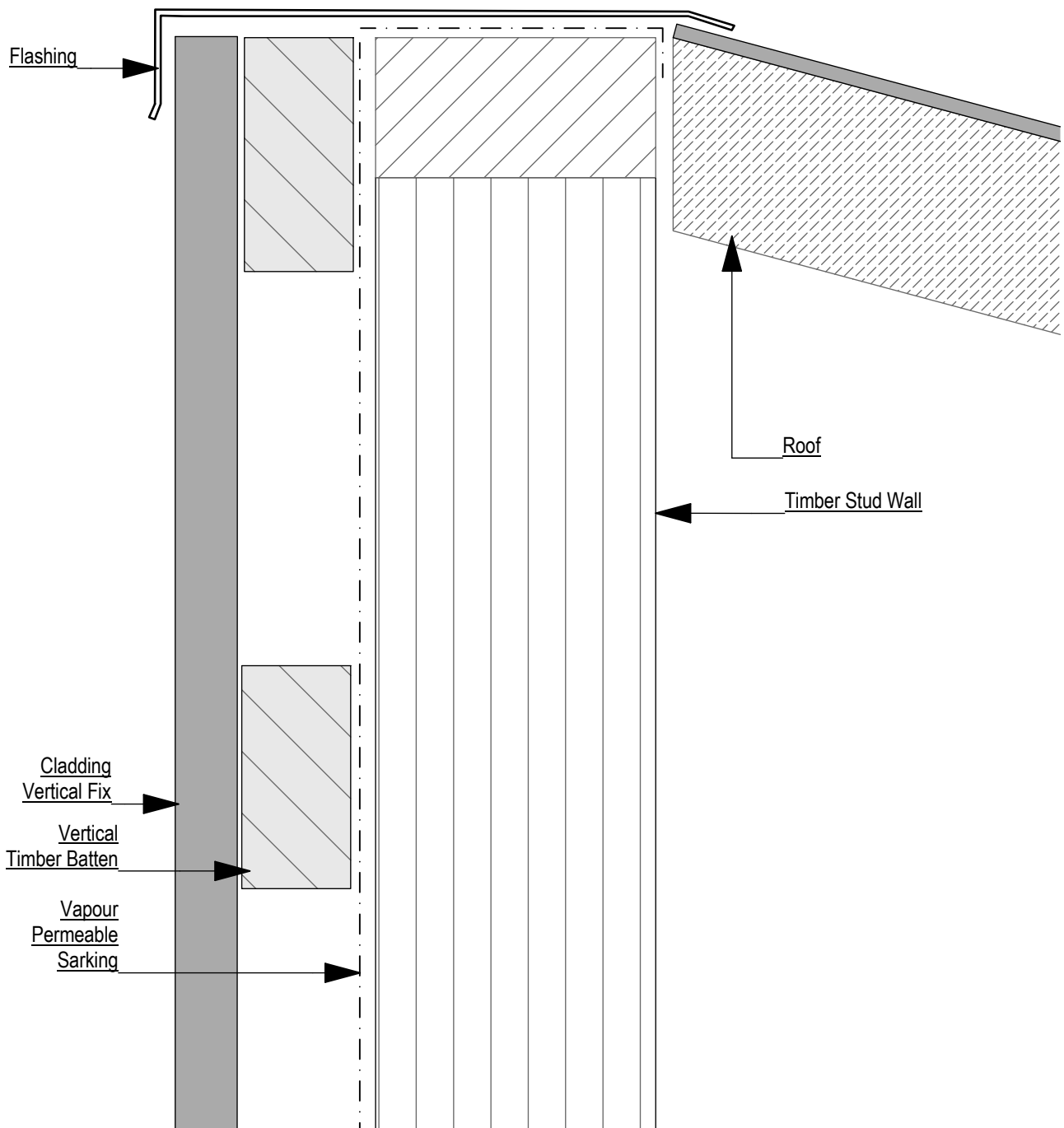

Dia 23: Horizontal Fix to Timber Wall Window Head Detail - Side View

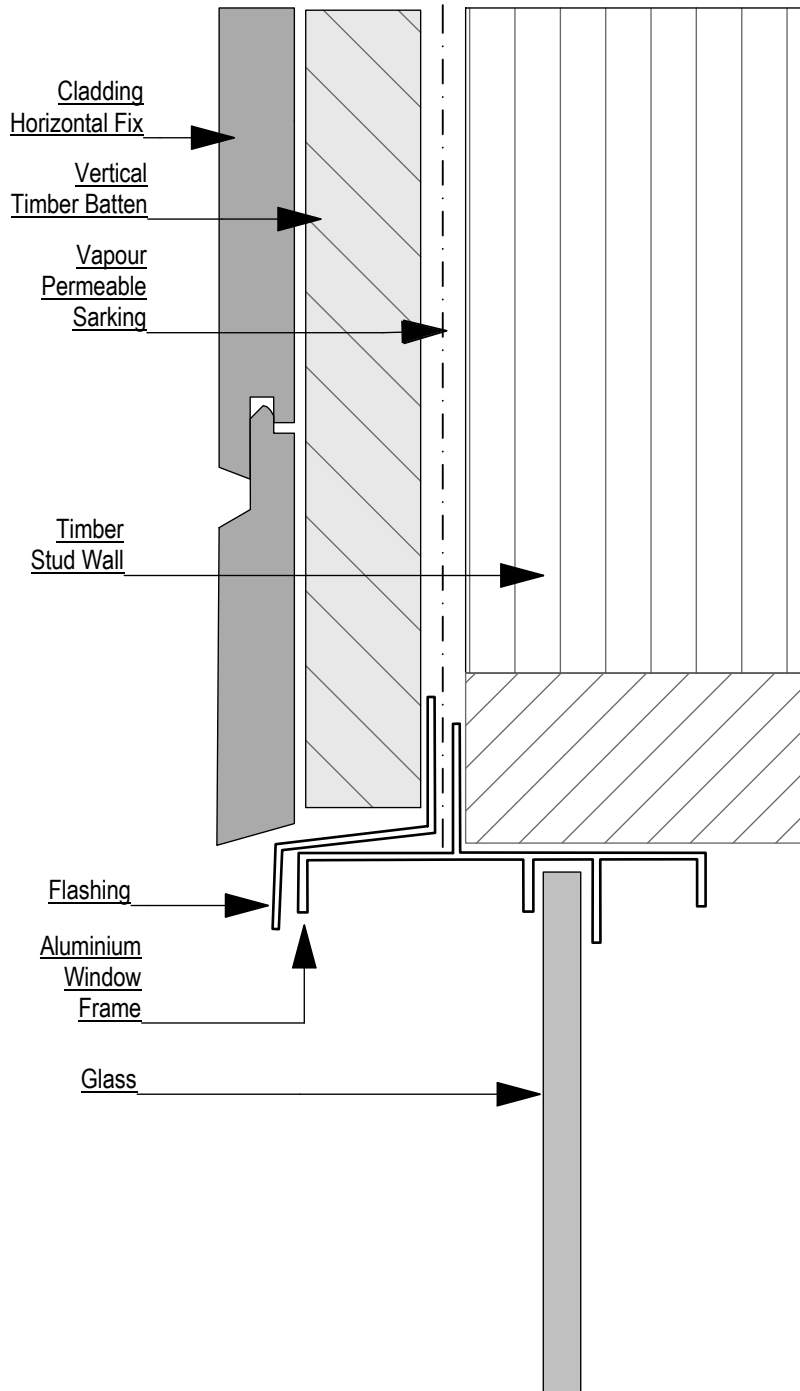

Dia 24: Vertical Fix to Timber Wall Window Head Detail - Side View

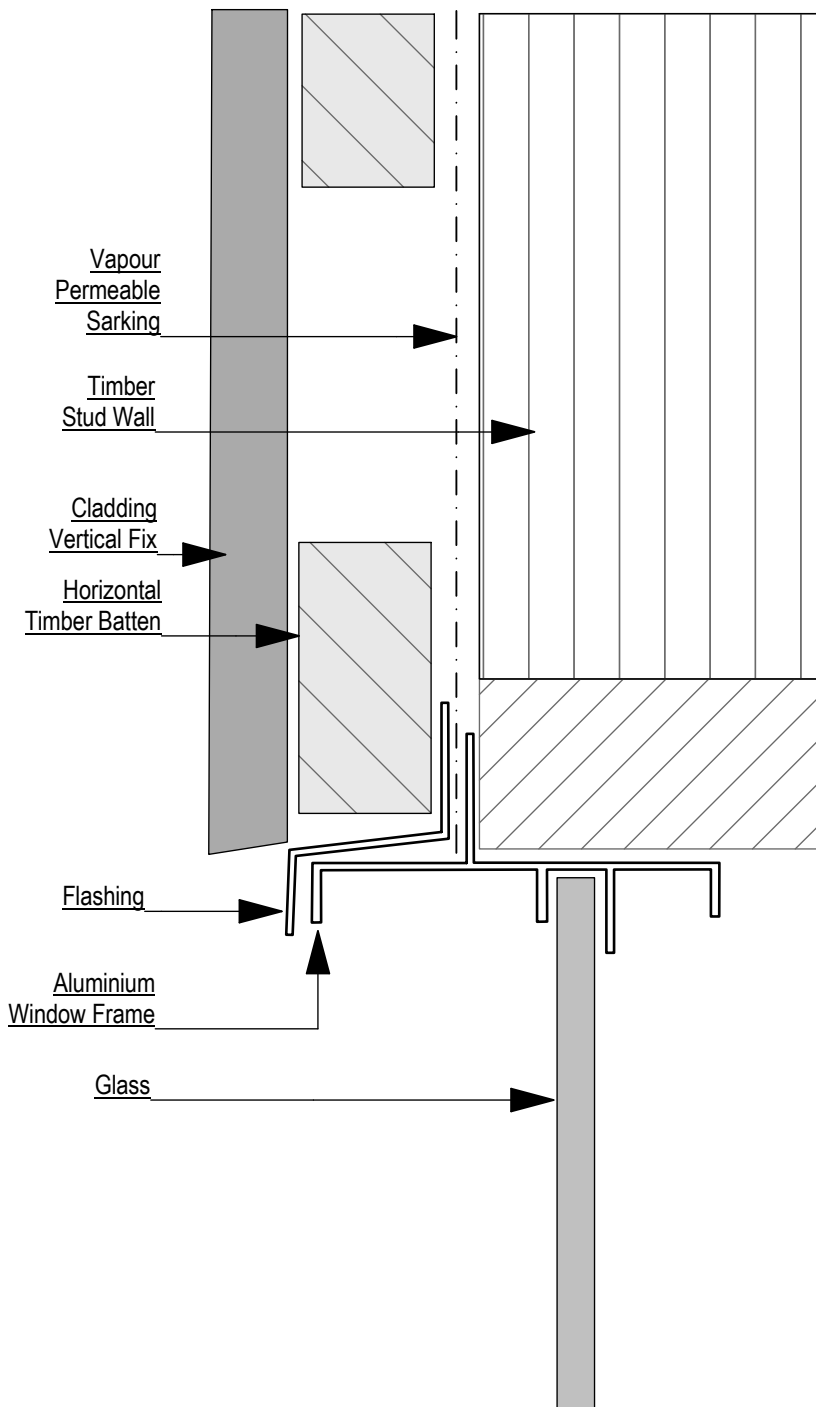

Dia 25: Horizontal Fix to Timber Wall Window Sill Detail - Side View

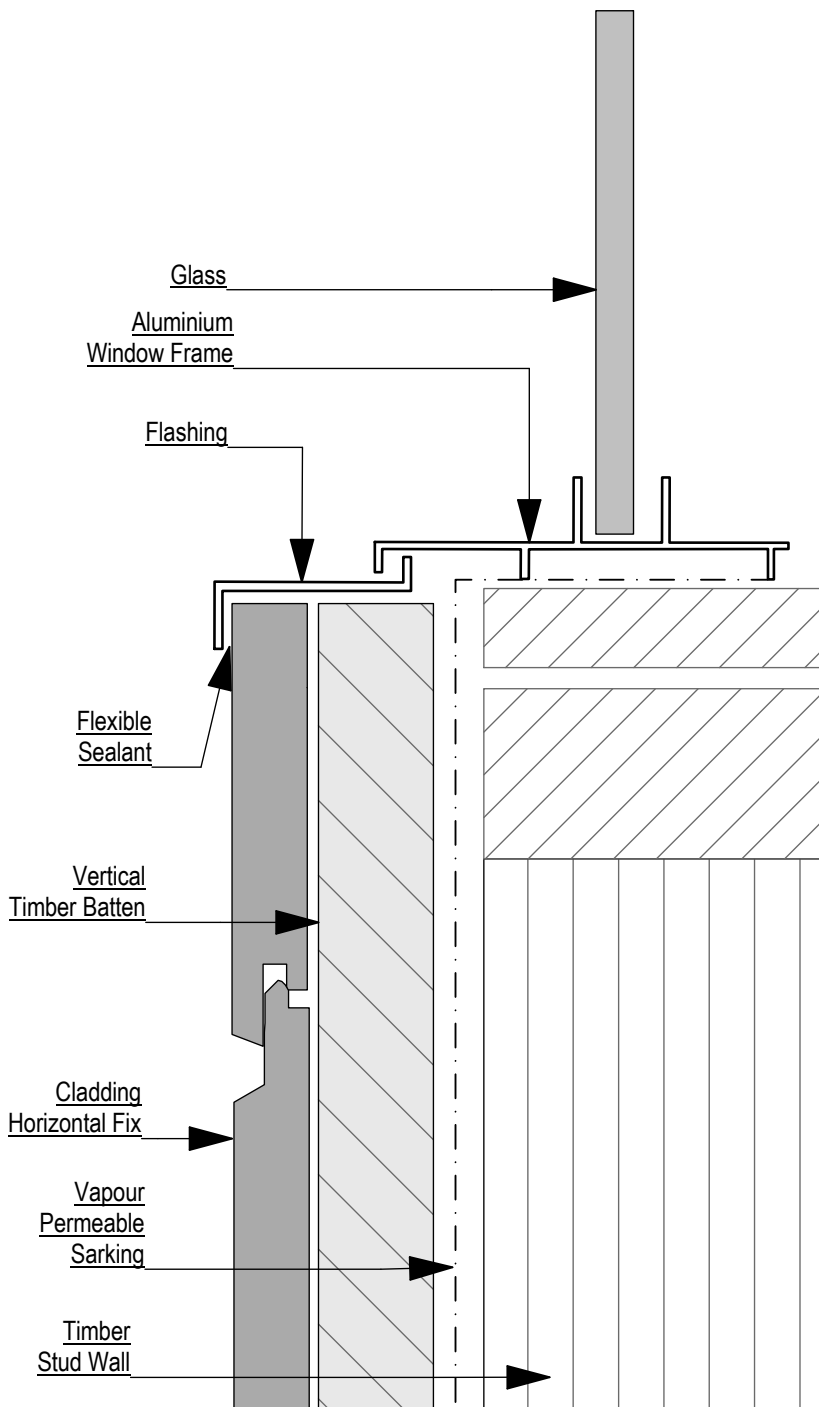

Dia 26: Vertical Fix to Timber Wall Window Sill Detail - Side View

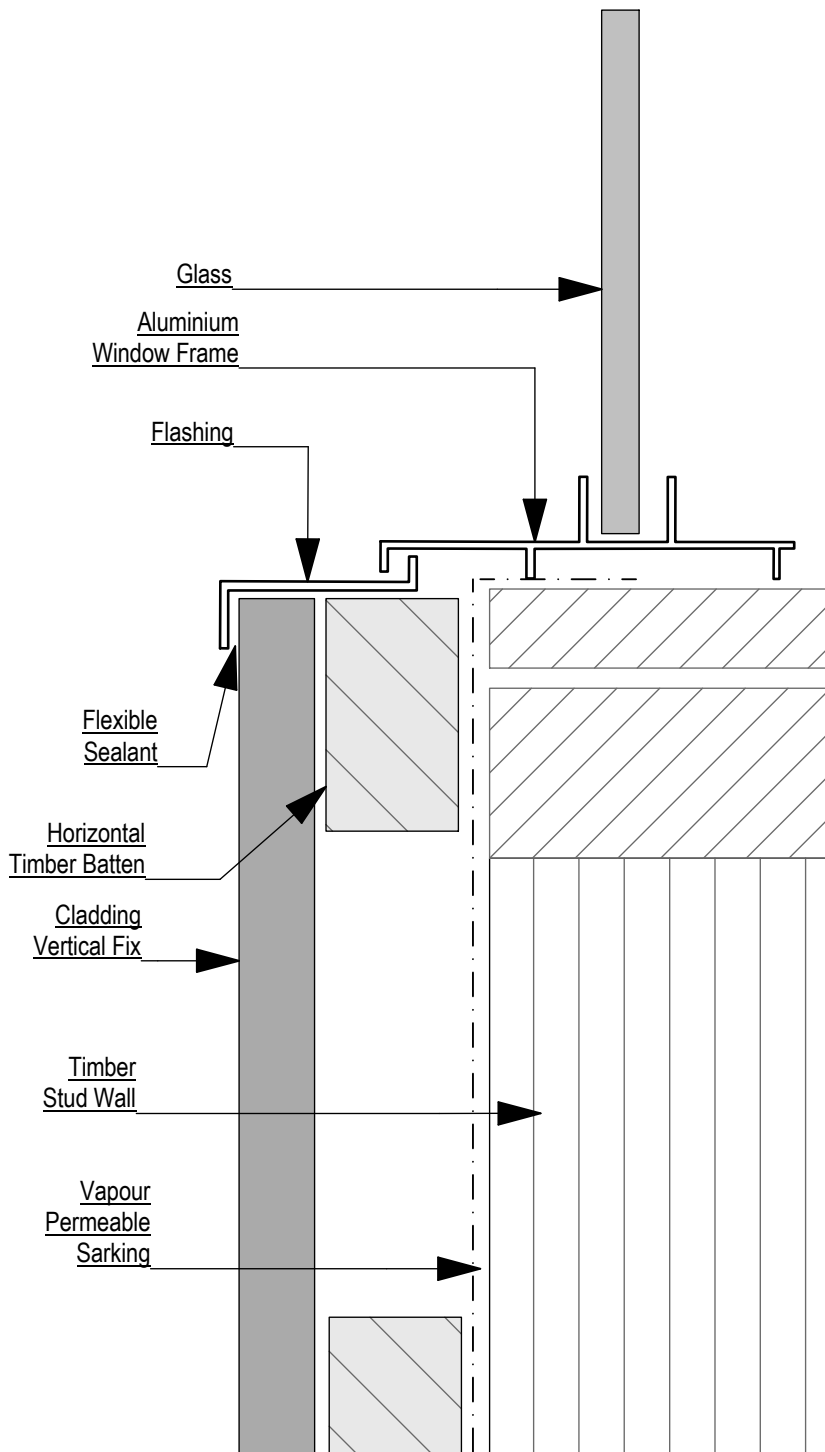

Dia 27: Horizontal Fix to Timber Wall Window Jamb Detail - Top View

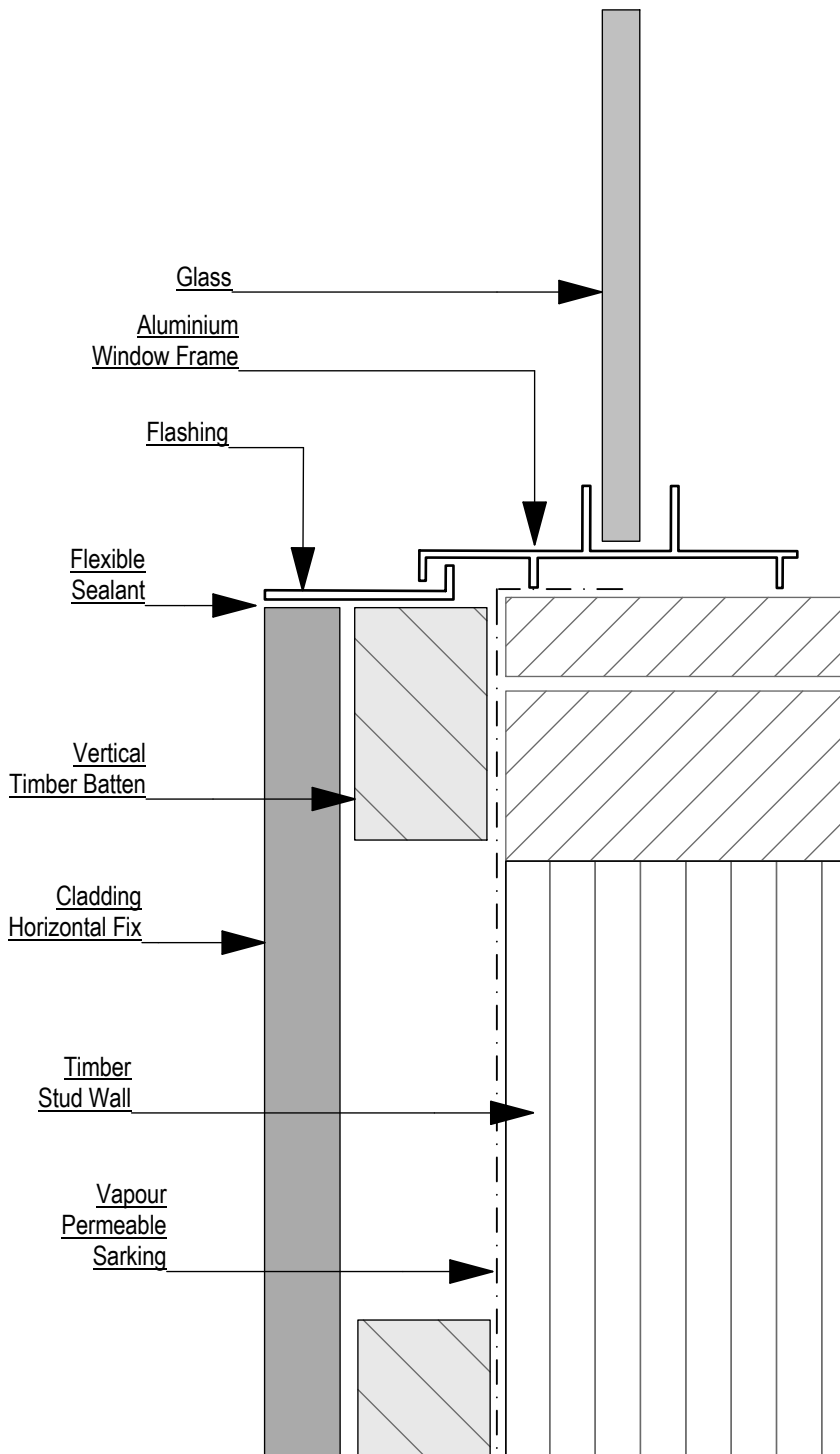

Dia 28: Vertical Fix to Timber Wall Window Jamb Detail - Top View

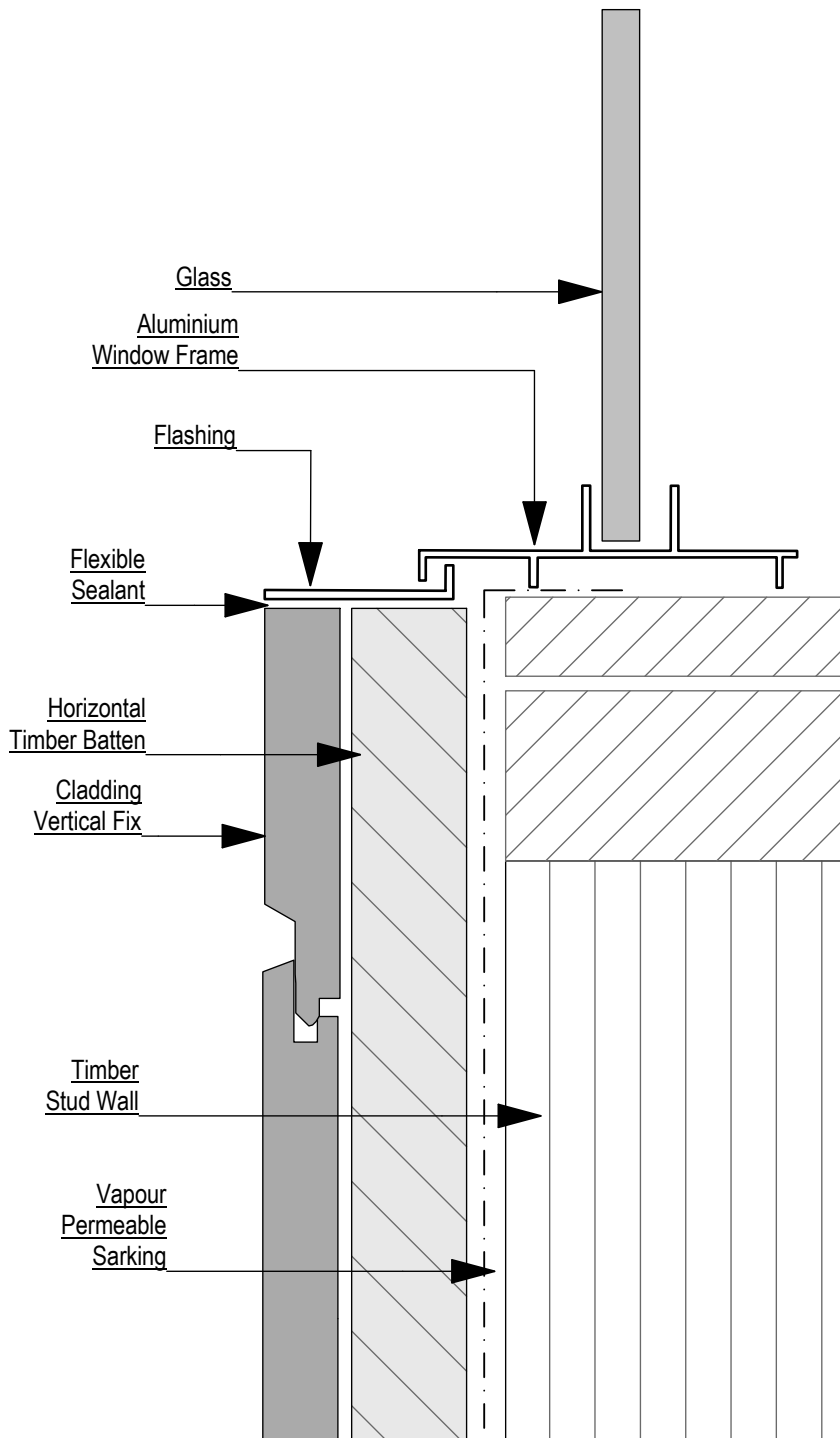

Dia 29: Internal Timber Profile

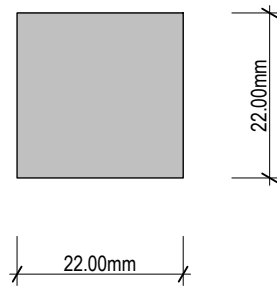

Dia 30: External Timber Profile

